

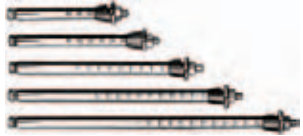















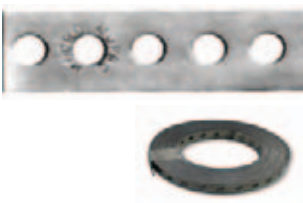









Prüfzeugnisse und Kennwerte für die Belastung können angefordert werden.



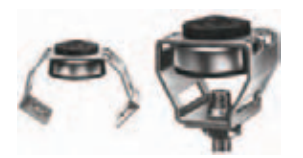



















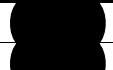
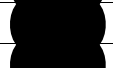

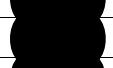
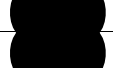
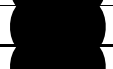
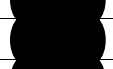
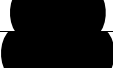
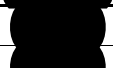
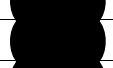
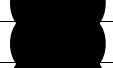

Kurz-Bezeichnung	Artikel	Größe	Menge, Stück		Bild
<b>LA-DÜ1</b>	Langschaftdübel Wandabstand regulierbar, tiefgreifender Halt, Abstandregulierung im Bohrloch, gleichbleibende Länge des Befestigungsgewindes auch während des Anziehens, Genauigkeit durch Maßskala, erforderliches Bohrloch Ø13mm	M8x90mm	1Stk.		
<b>LA-DÜ2</b>		M8x120mm	1Stk.		
<b>LA-DÜ3</b>		M8x160mm	1Stk.		
<b>LA-DÜ4</b>		M8x190mm	1Stk.		
<b>LA-DÜ5</b>		M8x240mm	1Stk.		
<b>KI-DÜ</b>	Kippdübel 1,95kN	M8x100mm	1Stk.		
<b>LO-BA</b>	Lochband, Loch Ø 6,5mm	17mm, 10m	1Rolle		
<b>SA-BA</b>	Schallschutzaufhängung für Lochband	M8	1Stk.		
<b>RSH</b>	Rohrschellenhalter	für Ø80 bis 160mm	1Stk.		
		für Ø180 bis 315mm	1Stk.		
		für Ø ab 350mm	1Stk.		
<b>GE-ST</b>	Gewindestange	M8x1000mm	1Stk.		
<b>LA-MU1</b>	Langmutter	M8x30mm	1Stk.		
<b>LA-MU2</b>	Langmutter	M8x50mm	1Stk.		
<b>PA-VE</b>	Parallel-Verbinder für Gewindestangen	M8	1Stk.		
<b>SA-AU</b>	Schallschutzaufhängung für Gewindestange 230N	M8	1Stk.		
<b>TR-HÄ1</b>	Trapezblechhänger Typ II mit Mutter M8	B=100mm	1Stk.		
<b>LU-BE</b>	Luftkanal-Befestiger (zum Aufschrauben oder Aufnieten)	30x2mm	1Stk.		

## Montagezubehör 2

Prüfzeugnisse und Kennwerte für die Belastung können angefordert werden.



























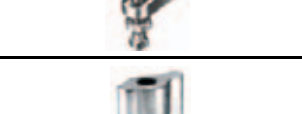



Kurz-Bezeichnung	Artikel	Größe	Menge, Stück		Bild
<b>RU-DI</b>	Rund-Dichtungsprofil für Sickenschellen	DN 5mm/96m	1 Rolle		
<b>GE-DI</b>	Gewebe-Dichtungsband 326 silber-grau	50mm, 50m	1 Rolle		
<b>ZE-GU</b>	Zellgummi, selbstklebend zwischen Kanälen zum Abdichten	24x3mm, 10m	1 Rolle		
<b>ZE-FI</b>	Zellfilz	30x3mm, 10m	1 Rolle		
<b>ZI-SP</b>	Zinkspray	400ml	1 Flasche		
<b>SE-SCH</b>	selbst schneidende Schrauben	4,2x13mm	500Stk.		
<b>BL-SCH</b>	Blechschauben	3,9x13mm	200Stk.		
<b>BAB-3</b>	Blech-An-Bohrer	3,1mm	5Stk.		
<b>BAB-4</b>	Blech-An-Bohrer	4,1mm	5Stk.		
<b>BL-NI</b>	Blindniete Alu	4x8mm	250Stk.		
<b>BL-ZA</b>	Blindnietzange	4-6mm	1Stk.		
<b>BE-S1</b>	Betonschrauben	M8x70mm	1Stk.		
<b>BE-S2</b>	Betonschrauben	M8x80mm	1Stk.		
<b>BE-S3</b>	Betonschrauben	M8x100mm	1Stk.		
<b>ST-SR1</b>	Stockschrauben	M8x60mm	100Stk.		
<b>ST-SR2</b>	Stockschrauben	M8x100mm	100Stk.		
<b>ST-SR3</b>	Stockschrauben	M8x120mm	100Stk.		
<b>ST-SR4</b>	Stockschrauben	M8x140mm	100Stk.		
<b>ST-SR5</b>	Stockschrauben	M8x160mm	100Stk.		
<b>ED-VO</b>	Eindrehvorsatz für Stockschrauben	M8	1Stk.		

Prüfzeugnisse und Kennwerte für die Belastung können angefordert werden.

Kurz-Bezeichnung	Artikel	Größe	Menge, Stück		Bild
TR-KR	Träger-Kralle für Profil 38/40	38/40mm	1Stk.		
VA-SA	Sattelflansch Vario	38/40mm	1Stk.		
IN-SH1	Installationsschienen	38/40mm	2m		
IN-SH2		38/40mm	3m		
IN-SH3		38/40mm	4m		
AB-HA1	Abhängeschienen 27/18 inkl. untere und seitliche Dämmung, mit Gewindestangen 2x1m, 2 Endkappen, weitere Größen auf Anfrage	M8, 580mm	1Stk.		
AB-HA2		M8, 850mm	1Stk.		
AB-HA3		M8, 1100mm	1Stk.		
AB-HA4		M8, 1580mm	1Stk.		
DE-AB1	Deckenabhängung mit Profil 38/40	L=200mm	1Stk.		
DE-AB2		L=300mm	1Stk.		
DE-AB3		L=400mm	1Stk.		
DE-AB4		L=600mm	1Stk.		
DE-AB5		L=800mm	1Stk.		
DE-AB6		L=1000mm	1Stk.		
DE-AB7		L=1500mm	1Stk.		
DE-AB8		L=2000mm	1Stk.		
ST-MA1	Ständer mit Profil 38/40	L=1200mm	1Stk.		
ST-MA2		L=1500mm	1Stk.		
ST-MA3		L=2000mm	1Stk.		
ST-MA4		L=2500mm	1Stk.		
WA-KO1	Wandkonsole mit Profil 38/40, mit Endkappe, Zwischengrößen möglich	L=200mm	1Stk.		
WA-KO2		L=300mm	1Stk.		
WA-KO3		L=400mm	1Stk.		
WA-KO4		L=600mm	1Stk.		
WA-KO5		L=800mm	1Stk.		
WA-KO6		L=1000mm	1Stk.		
KO-SE1	für schallgedämmte Konsole, Befestigung von Klimageräten, Wasserwerken, Pumpen, Kompressoren, Ventilatoren	L=480mm	1Set		
KO-SE2		L=560mm	1Set		
KO-SE3		L=640mm	1Set		
KO-WI	Konsolenwinkel und Konstruktionswinkel	200x200x6mm	1Stk.		

# Montagezubehör 4

Prüfzeugnisse und Kennwerte für die Belastung können angefordert werden.

Kurz-Bezeichnung	Artikel	Größe	Menge, Stück		Bild
<b>LU-WI</b>	Luftkanal-Winkel Typ I (zum Aufschrauben oder Nieten)	90x30x3mm	1Stk.		
<b>LU-DW</b>	Luftkanal-Doppelwinkel Typ I (zum Aufschrauben oder Nieten)	60x30x3mm	1Stk.		
<b>WI-HÄ</b>	Winkel-Hänger, seitliche Abhängung	120x80x58mm	1Stk.		
<b>GS-SH</b>	Gewindestangen- Schnellhänger	8mm	1Stk.		
<b>AU-BÜ</b>	Aufhängebügel für Gewindestange an Decke oder Wand	M8	1Stk.		
<b>TR-KL</b>	Träger-Klammer	M8	1Stk.		
<b>KR-HA</b>	Krafthaken	8mm	1Stk.		
<b>PE-AU</b>	Pendelaufhängung	M8	1Stk.		
<b>HA-KO1</b>	Hammerkopfbefestiger für Profil 38/40 zum freien Eindrehen	M8x90mm	1Stk.		
<b>HA-KO2</b>		M8x100mm	1Stk.		
<b>HA-KO3</b>		M8x140mm	1Stk.		
<b>HA-KO4</b>		M8x180mm	1Stk.		
<b>SCH-MU</b>	Schiebemutter für Gewindestange im Profil 38/40	M8	1Stk.		
<b>SCH-BÜ1</b>	geräuschloser Rollgleiter, regulierbar, besonderes Einsatzgebiet wo sich Schläuche verdrehen müssen	M8	1Paar		
<b>SCH-BÜ2</b>		M10			
<b>DÄ-PU</b>	Dämmlastpuffer	43/10,5mm	1Stk.		
<b>DÄ-SCH</b>	Dämmscheibe	28x8,5mm	1Stk.		
<b>U-SCH</b>	U-Scheiben	M8/36mm	10Stk.		

Prüfzeugnisse und Kennwerte für die Belastung können angefordert werden.

Kurz-Bezeichnung	Artikel	Größe	Menge, Stück		Bild
<b>SCH-BÜ</b>	Schienen-Bügel für Profil 38/40	116x40x41mm	1Stk.		
<b>AB-WI</b>	End-Montagewinkel 90°, 38/40	38x38x4mm	1Stk.		
<b>MO-WI</b>	Montagewinkel 90° lang, 38/40	106x86x6mm	1Stk.		
<b>AB-KA</b>	Abschlussklappe 38/40	38x40 mm	1Stk.		
<b>KA-VE</b>	Kanalverbinder, einfache und schnelle Montage von Kanälen	M8x20mm	1Stk.		
<b>SCH-EK</b>	Schallschutz Entkoppler dB 27	M10x147mm	2Stk.		
<b>SCH-FU</b>	Schallschutz Fuß	M12x108mm	2Stk.		
<b>DÄ-SO</b>	Dämmsockel mit Winkelanschlag	90x90mm	4Stk.		
<b>SCH-KN</b>	Schallschutz Knopf, guter Schallschutz für Motore, Ventilatoren, Kompressoren, Kessel, Pumpen, Maschinen	M10x64mm	2Stk.		
<b>DR-TO1</b>	Drehkranz-Torsionsausgleich, ideal beim Einsatz von PU-Schläuchen an CNC-Maschinen, weitere Größen auf Anfrage!	für d1 160 - 180mm	1Stk.		
<b>DR-TO2</b>		200 - 280mm	1Stk.		
<b>DR-TO3</b>		300 - 500mm	1Stk.		

Weiteres Zubehör auf Anfrage!

## Kurzbezeichnung

WI-HÄ

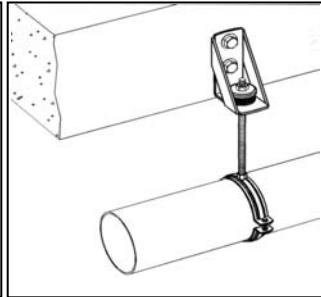
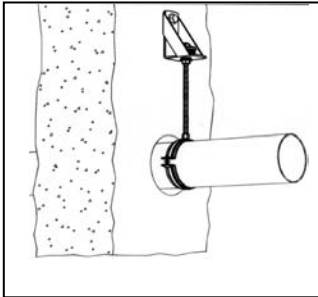

KO-WI

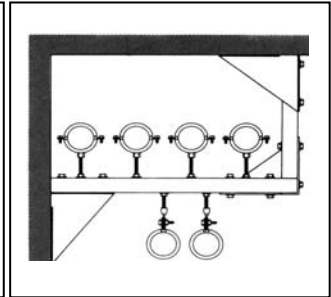
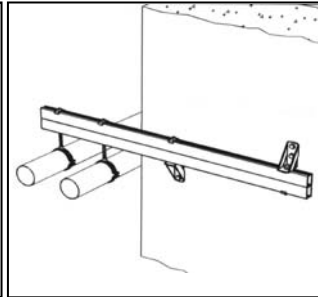

AB-HA

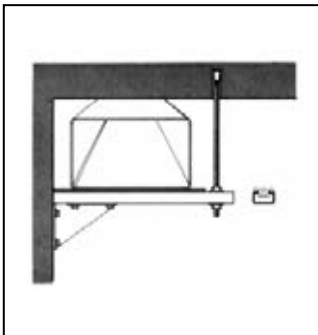

LU-WI

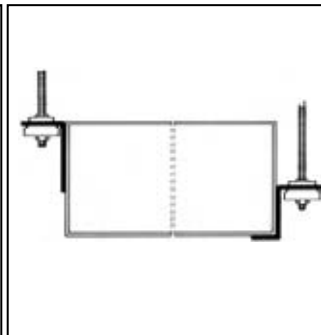

KA-VE

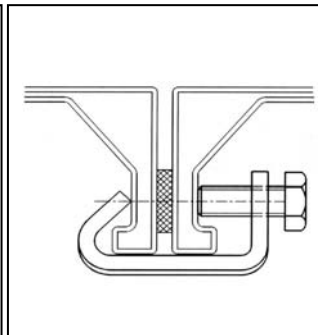

DE-AB

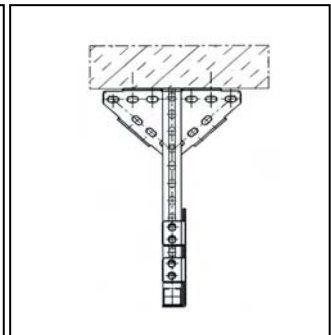

DÄ-PU



ST-MA



LU-BE

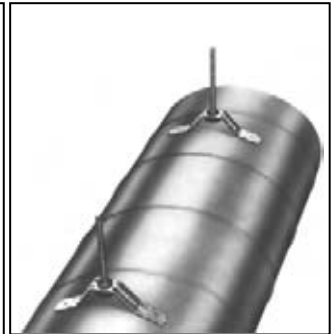

SA-AU



RSH





Kurzbezeichnung

SCH-BÜ



SCH-WA



WA-KO



LO-BA



HA-KO



PE-AU



VA-SA



TR-KR



AU-BÜ



TR-HÄ



SCH-BÜ

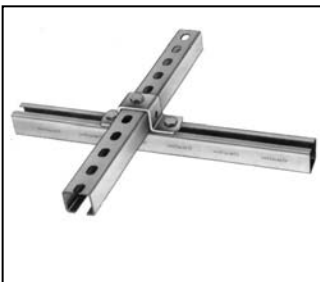

LA-DÜ



TR-KR

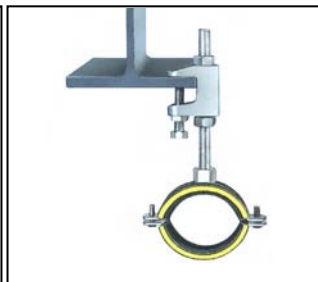

TR-HÄ

